

Lüftertaster/
Lüfterschalter LTA-LSA

Vent switch LTA-LSA

DE Montageanleitung
GB Installation instructions

120526-04



Germany
GEZE Sonderkonstruktionen GmbH
Planken 1
97944 Boxberg-Schweigern
Tel. +49 (0) 7930 9294 0
Fax +49 (0) 7930 9294 10
E-Mail: sk.de@geze.com
GEZE GmbH
Niederlassung Süd-West
Tel. +49 (0) 7152 203 594
E-Mail: leonberg.de@geze.com
GEZE GmbH
Niederlassung Süd-Ost
Tel. +49 (0) 7152 203 6440
E-Mail: muenchen.de@geze.com
GEZE GmbH
Niederlassung Ost
Tel. +49 (0) 7152 203 6840
E-Mail: berlin.de@geze.com
GEZE GmbH
Niederlassung Mitte/Luxemburg
Tel. +49 (0) 7152 203 6888
E-Mail: frankfurt.de@geze.com
GEZE GmbH
Niederlassung West
Tel. +49 (0) 7152 203 6770
E-Mail: essen.de@geze.com
GEZE GmbH
Niederlassung Nord
Tel. +49 (0) 7152 203 6600
E-Mail: hamburg.de@geze.com
GEZE Service GmbH
Tel. +49 (0) 1802 923392
E-Mail: service-info.de@geze.com

Austria
GEZE Austria
E-Mail: austria.at@geze.com
www.geze.at

Baltic States
GEZE GmbH Baltic States office
E-Mail: office-latvia@geze.com
www.geze.com

Benelux
GEZE Benelux B.V.
E-Mail: benelux.nl@geze.com
www.geze.be
www.geze.nl

Bulgaria
GEZE Bulgaria - Trade
E-Mail: office-bulgaria@geze.com
www.geze.bg

China
GEZE Industries (Tianjin) Co., Ltd.
E-Mail: chinasales@geze.com.cn
www.geze.com.cn
GEZE Industries (Tianjin) Co., Ltd.
Branch Office Shanghai
E-Mail: chinasales@geze.com.cn
www.geze.com.cn
GEZE Industries (Tianjin) Co., Ltd.
Branch Office Guangzhou
E-Mail: chinasales@geze.com.cn
www.geze.com.cn
GEZE Industries (Tianjin) Co., Ltd.
Branch Office Beijing
E-Mail: chinasales@geze.com.cn
www.geze.com.cn

France
GEZE France S.A.R.L.
E-Mail: france.fr@geze.com
www.geze.fr

Hungary
GEZE Hungary Kft.
E-Mail: office-hungary@geze.com
www.geze.hu

Iberia
GEZE Iberia S.R.L.
E-Mail: info@geze.es
www.geze.es

India
GEZE India Private Ltd.
E-Mail: office-india@geze.com
www.geze.in

Italy
GEZE Italia S.r.l.
E-Mail: italia.it@geze.com
www.geze.it

GEZE Engineering Roma S.r.l.
E-Mail: roma@geze.biz
www.geze.it

Poland
GEZE Polska Sp. z o.o.
E-Mail: geze.pl@geze.com
www.geze.pl

Romania
GEZE Romania S.R.L.
E-Mail: office-romania@geze.com
www.geze.ro

Russia
OOO GEZE RUS
E-Mail: office-russia@geze.com
www.geze.ru

Scandinavia – Sweden
GEZE Scandinavia AB
E-Mail: sverige.se@geze.com
www.geze.se

Scandinavia – Norway
GEZE Scandinavia AB avd. Norge
E-Mail: norge.se@geze.com
www.geze.no

Scandinavia – Denmark
GEZE Danmark
E-Mail: danmark.se@geze.com
www.geze.dk

Singapore
GEZE (Asia Pacific) Pte, Ltd.
E-Mail: gezesea@geze.com.sg
www.geze.com

South Africa
GEZE Distributors (Pty) Ltd.
E-Mail: info@gezesa.co.za
www.geze.co.za

Switzerland
GEZE Schweiz AG
E-Mail: schweiz.ch@geze.com
www.geze.ch

Turkey
GEZE Kapi ve Pencere Sistemleri
E-Mail: office-turkey@geze.com
www.geze.com

Ukraine
LLC GEZE Ukraine
E-Mail: office-ukraine@geze.com
www.geze.ua

United Arab Emirates/GCC
GEZE Middle East
E-Mail: gezeme@geze.com
www.geze.ae

United Kingdom
GEZE UK Ltd.
E-Mail: info.uk@geze.com
www.geze.com

GEZE GmbH
Reinhold-Vöster-Straße 21–29 Tel.: 0049 7152 203 0
71229 Leonberg Fax: 0049 7152 203 310
Germany www.geze.com



Bezeichnung / Description

Lüftertaster/Lüfterschalter, 1-fach Rahmen AS 500 alpinweiß,
Mat. Nr. 118476.

Vent switch, single frame AS 500 alpine white, Mat. no. 118476

Zubehör / Accessories

Name	Mat. Nr.
AS 500 UP-Rahmen / AS 500 concealed frame	
□ 1-fach / single	115376
□ 2-fach / double	115377
□ 3-fach / triple	115378
□ 4-fach / quadruple	115379
□ 5-fach / quintuple	115380
AS 500 Aufputzdose / AS 500 Surface-mounted box	
□ 1-fach / single	120503
□ 2-fach / double	128609
□ 3-fach / triple	133206
Zwischenrahmen 55x55 für ST 550 alpinweiß / intermediate frame 55x55 for ST 550 alpine white	155851
Zwischenrahmen 55x55 für LS 990 alpinweiß / intermediate frame 55x55 for LS 990 alpine white	148997
Zwischenrahmen 55x55 für LS 990 edelstahl / intermediate frame 55x55 for LS 990 stainless steel	131822
AS 500 Blindabdeckung BAB / AS 500 dummy cover BAB	118480
SCT (1-pol.)	117996

Passende Schalterprogramme / Matching switch ranges

Jung

- AS 500
- LS 990 (mit Zwischenrahmen / with intermediate frame)
- ST550 (mit Zwischenrahmen / with intermediate frame)

Gira

- Standard 55
- E2
- Event

Feller

- EDIZIOdue

Merten

- System M

Berker

- B3
- B7
- S1

Technische Daten / Technical data

Variante Variant	Spannung Voltage	Strom Current
LTA-LSA	230 V AC	max. 10 A
Schutzart / Protection rating	IP 40	

Maßzeichnungen / Dimensional drawings

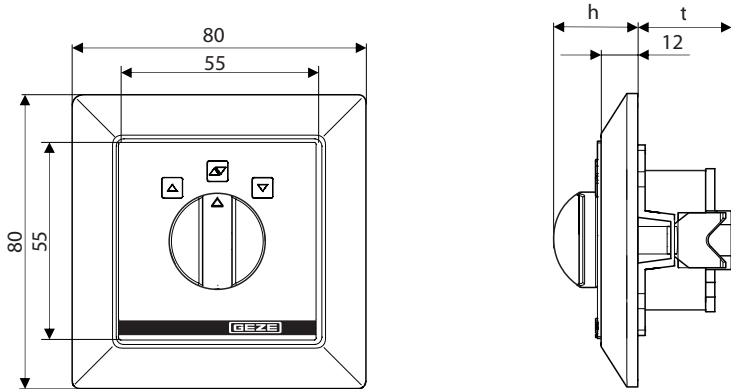

Zusammenbau / Assembly

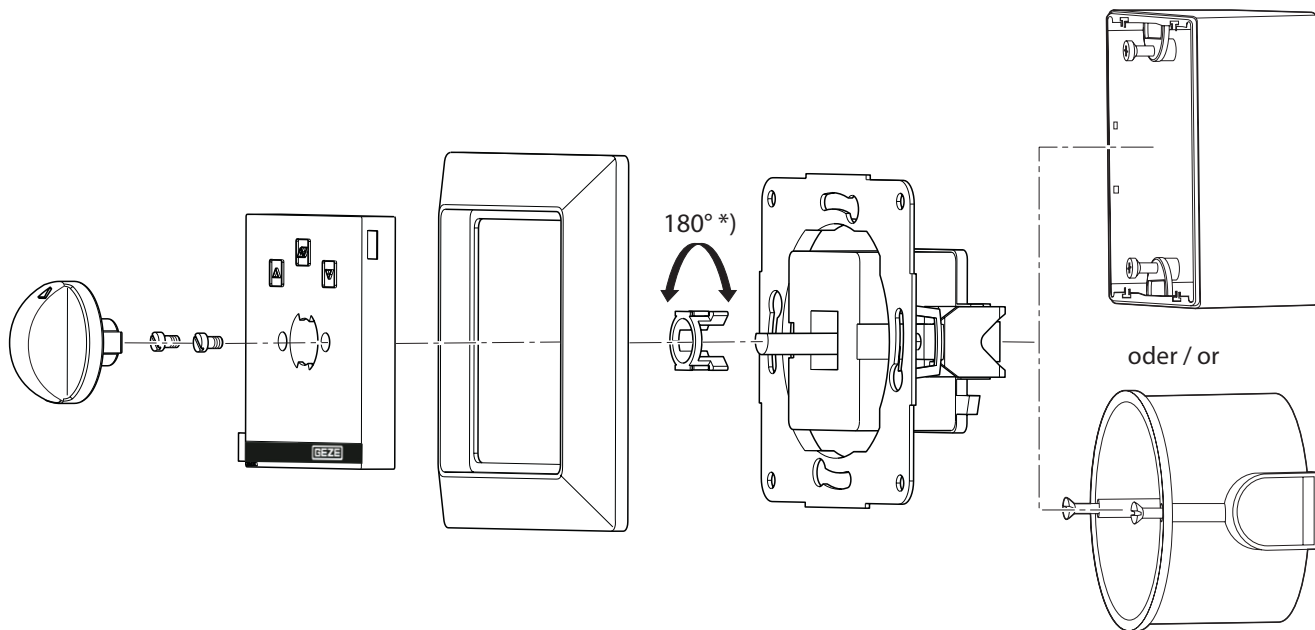

*) wahlweise Tast- oder Rastfunktion;
Auslieferungszustand: rastend

*) with optional touch or latching function;
standard delivery: latching function

Schablone für Pfostenmontage / Template for installation on a post



Die Papierschablone kann sich abhängig von der Luftfeuchtigkeit maßlich verändern. Verbindlich sind daher nur die Maßangaben.

► Vor der Verwendung Papierschablone maßlich kontrollieren und ggf. korrigieren.

The dimensions of the paper template can change depending on air humidity. For this reason, only our dimensional specifications are applicable.

► Before using the paper template check the dimensions and correct if necessary.

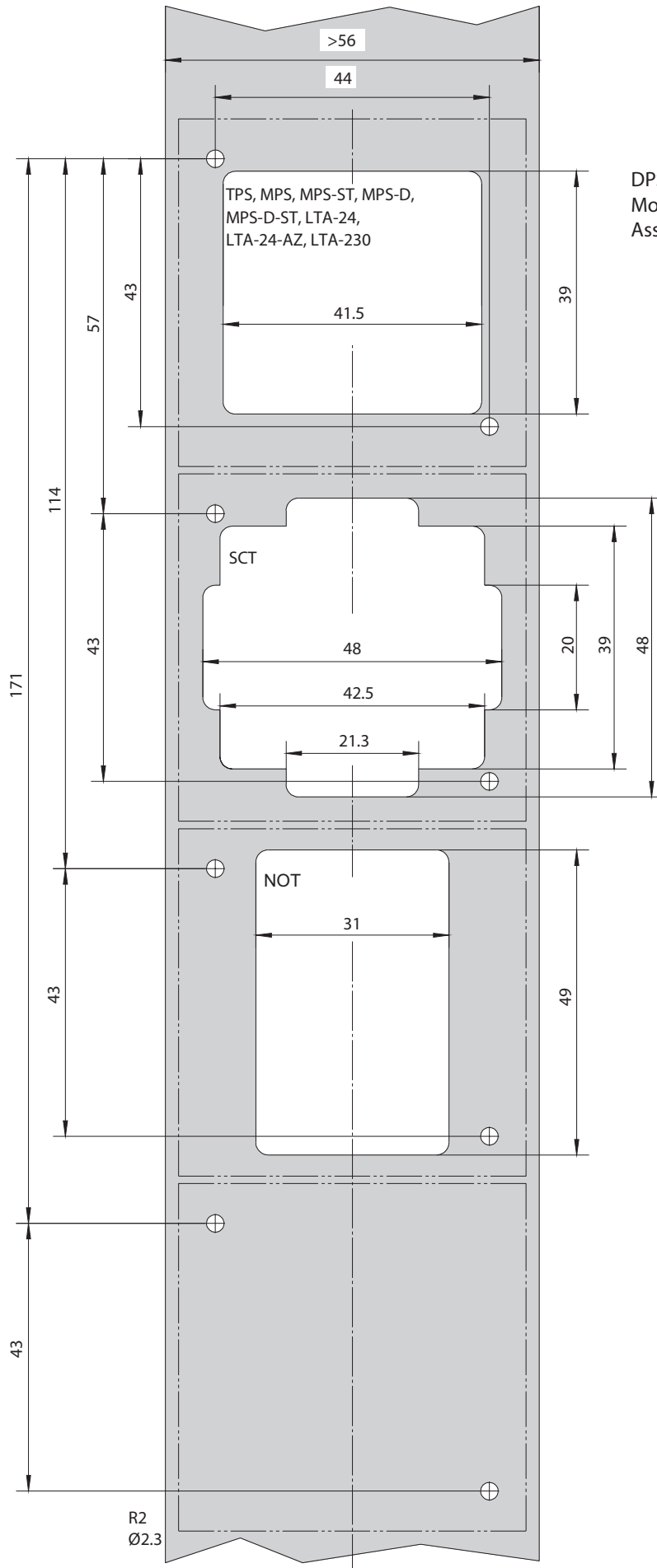

DPS, LTA-LSA:
Montage in Pfosten nicht möglich. /
Assembly on a post not possible.

Schaltpläne / Circuit diagrams

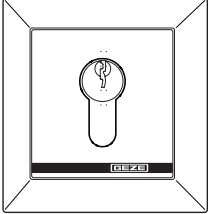
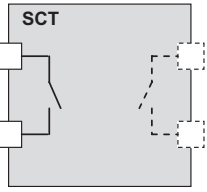
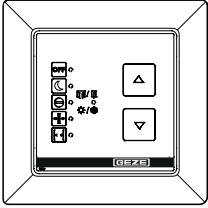
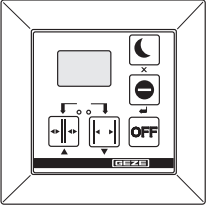
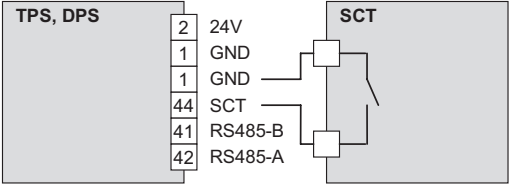
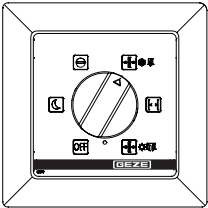
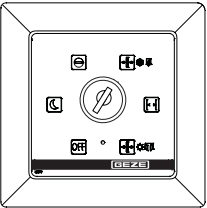
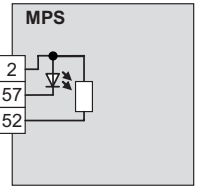
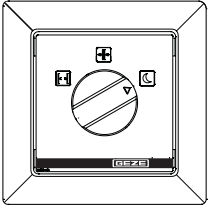
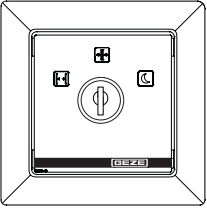
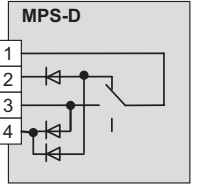
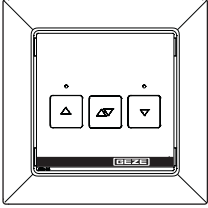
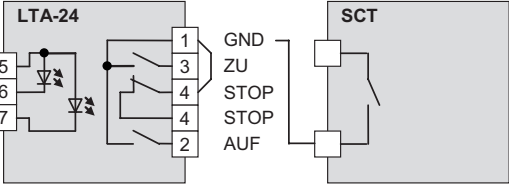
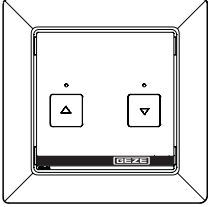
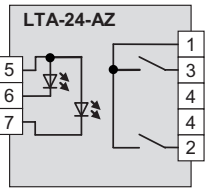
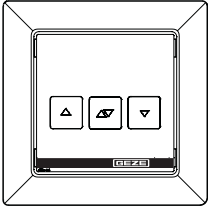
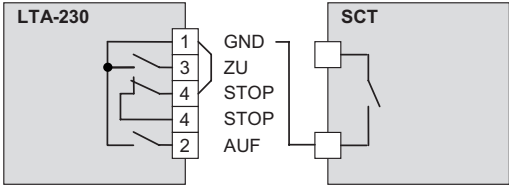
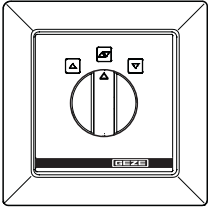
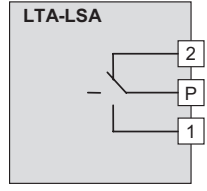
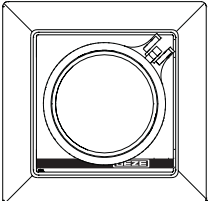
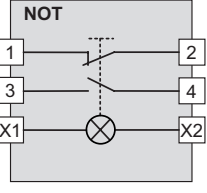
Taster / Switches	Bezeichnung / Description	Mat. Nr. / Mat.No.	Taster / Switches	Bezeichnung / Description	Mat. Nr. / Mat. No.	Schaltplan / Circuit diagram	h [mm]	t [mm]
	SCT (1-pol.)	117996		-	-		11	31.9
	TPS TPS-SCT TPS-KDT TPS-KDT-SCT DPS mit/with OFF DPS ohne/ without OFF DPS mit/with OFF SCT	113231 113232 126582 126583 151524 155809 155810		TPS, DPS			11.3	5.3 31.9
	MPS	113226		MPS-ST	113227		24	36
	MPS-D	118417		MPS-D-ST	118418		24	36
	LTA-24 LTA-24-SCT	118473 127176		LTA-24			11	26
	LTA-24-AZ	129393		LTA-24-AZ			11	26
	LTA-230 LTA-230-SCT	118474 118475		LTA-230			11	26
	LTA-LSA	118476		LTA-LSA			24	32
	NOT	123132		NOT			54	56